

Model 1540E.44101 Shown  
(Rails sold separately)

## 15 Frame Plunger Pump Triethylene Glycol (TEG) Dehydration

**Standard  
Model**

**1540E.44101**

**Stainless Steel  
Model**

**1541.44101**

### FEATURES

- Designed for continuous-duty performance for triethylene glycol (TEG) gas dehydration where low life cycle costs are a must.
- Field tested, high pressure triplex pump configured for TEG temperatures up to 240° F (116° C).
- Positive displacement technology for optimum energy efficiency.

### SPECIFICATIONS

	U.S. Measure	Metric Measure
Flow .....	18.0 gpm	(68 lpm)
Pressure Range.....	100 to 1200 psi	(7 to 85 bar)
RPM .....	1100 rpm	(1100 rpm)
Inlet Pressure Range.....	Flooded to 70 psi	(Flooded to 4.9 bar)
Bore .....	1.181"	(30 mm)
Stroke.....	1.181"	(30 mm)
Crankcase Capacity.....	42 oz.	(1.26 L)
Maximum Liquid Temperature .....	240°F	(116°C)
Inlet Ports (2) .....	1" NPTF	(1" NPTF)
Discharge Ports (2).....	3/4" NPTF	(3/4" NPTF)
Pulley Mounting .....	Either Side	(Either Side)
Shaft Diameter .....	1.181"	(30 mm)
Weight.....	42.6 lbs.	(21 kg)
Dimensions.....	14.79 x 12.99" x 8.25	(376 x 330 x 210mm)

### ELECTRIC HORSEPOWER REQUIREMENTS

FLOW		PRESSURE			RPM
		psi 800	psi 1000	psi 1200	
U.S. gpm	lpm	bar 55	bar 70	bar 85	
18	68	9.9	12.3	14.8	1100
15	57	8.2	10.3	12.3	917

#### ⚠ CAUTIONS AND WARNINGS

All High Pressure Systems require a primary pressure regulating device (i.e. regulator, unloader) and a secondary pressure relief device (i.e. pop-off valve, relief valve). Failure to install such relief devices could result in personal injury or damage to pump or property. CAT PUMPS does not assume any liability or responsibility for the operation of a customer's high pressure system.

Read all CAUTIONS and WARNINGS before commencing service or operation of any high pressure system. The CAUTIONS and WARNINGS are included in each service manual and with each Accessory Data sheet. CAUTIONS and WARNINGS can also be viewed online at [www.catpumps.com/cautions-warnings](http://www.catpumps.com/cautions-warnings) or can be requested directly from CAT PUMPS.

#### WARRANTY

View the Limited Warranty on-line at [www.catpumps.com/warranty](http://www.catpumps.com/warranty).

<b>DETERMINING THE PUMP R.P.M.</b>	$\frac{\text{Rated gpm}}{\text{Rated rpm}}$	=	$\frac{\text{"Desired" gpm}}{\text{"Desired" rpm}}$
<b>DETERMINING THE REQUIRED H.P.</b>	$\frac{\text{gpm} \times \text{psi}}{1460}$	=	Electric Brake H. P. Required
<b>DETERMINING MOTOR PULLEY SIZE</b>	$\frac{\text{Motor Pulley O.D.}}{\text{Pump rpm}}$	=	$\frac{\text{Pump Pulley O.D.}}{\text{Motor rpm}}$

See complete Drive Packages [Incls: Pulleys, Belts, Hubs, Key] Tech Bulletin 003. Refer to pump **Service Manual** for repair procedure and additional technical information.

# PARTS LIST

ITEM	PART NUMBER		MATERIAL		DESCRIPTION	QTY
	1540E.44101	MATL	1541.44101	MATL		
5	92538	S	92538	S	Screw, HHC Sems (M6x16)	8
8	<b>49535</b>	<b>ALE</b>	<b>43496</b>	<b>AL</b>	Cover, Bearing	2
9	815281	FBR	815281	FBR	Shim, Split 2-Pc	3
10	76340	FPM	76340	FPM	O-Ring, Bearing Cover - 75D	2
11	76491	FPM	76491	FPM	Seal, Oil, Crankshaft - 70D	2
12	814800	S	814800	S	Shim, Split, 2-Pc	2
15	39060	STL	39060	STL	Bearing, Roller	2
20	48600	TNM	48600	TNM	Rod, Connecting Assembly	3
25	43494	FCM	43494	FCM	Crankshaft, Dual-End (M30)	1
31	76411	BB	76411	BB	Adapter, 3/4" NPT	1
32	992623	BB	992623	BB	Nipple, Close 3/4" NPT	1
33	76331	STCP	76331	STCP	Cap, Vented	1
36	76792	SS	76792	SS	Gauge, Sight	1
37	76791	AL	76791	AL	Adapter, Sight	1
38	44428	NBR	44428	NBR	Gasket, Flat, Adapter - 80D	1
40	92542	S	92542	S	Screw, HHC Sems (M6x20)	4
48	25625	STCP	25625	STCP	Plug, Drain (1/4"x19BSP)	1
49	30322	FPM	30322	FPM	O-Ring, Drain Plug	1
50	<b>49276</b>	<b>ALE</b>	<b>43491</b>	<b>AL</b>	Cover, Rear	1
51	76834	FPM	76834	FPM	O-Ring, Rear Cover - 75D	1
53	<b>49273</b>	<b>ALE</b>	<b>48925</b>	<b>AL</b>	Crankcase (Includes Guidepin)	1
64	43507	CM	43507	CM	Pin, Crosshead	3
65	<b>48933</b>	<b>SHS</b>	<b>49611</b>	<b>SS</b>	Rod, Plunger (Center)	1
66	<b>48931</b>	<b>SHS</b>	<b>49609</b>	<b>SS</b>	Rod, Plunger (Outside)	2
69	126596	STCP R	126596	STCP R	Washer, Oil Seal	3
70	76500	FPM	76500	FPM	Seal, Oil Crankcase	3
75	48937	S	48937	S	Slinger, Barrier	3
90	48938	CC	48938	CC	Plunger, Ceramic (M30x65)	3
98	48394	FPM	48394	FPM	Washer, Seal - 90D	3
99	† 48201	SS	† 48201	SS	Retainer, Plunger	3
100	76926	AL	76926	AL	Retainer, Seal	3
106	702939	ST4	702939	ST4	Seal, LPS w/NIH-Spg	3
110	<b>48940</b>	<b>FBB</b>	<b>49614</b>	<b>SS</b>	Manifold, Inlet	1
112	76903	FPM	76903	FPM	O-Ring, Inlet Manifold - 80D	3
117	49044	S	49044	S	Screw, HSH (M10x25)	4
125	702945	ST4	702945	ST4	Seal, HPS	3
155	76903	FPM	76903	FPM	O-Ring, Spacer - 80D	6
157	<b>48946</b>	<b>BB</b>	<b>49621</b>	<b>SS</b>	Spacer, HPS	3
163	14331	FPM	14331	FPM	O-Ring, Seat - 70D	6
164	<b>48951</b>	<b>S</b>	<b>49626</b>	<b>SS</b>	Seat	6
166	48686	SS	48686	SS	Valve	6
167	48687	SS	48687	SS	Spring, Valve	6
168	48994	PVDF	48994	PVDF	Retainer, Spring	6
170	<b>123764</b>	<b>S</b>	<b>49627</b>	<b>SS</b>	Washer, Spring Retainer	6
172	14183	FPM	14183	FPM	O-Ring, Valve Plug	3
174	<b>48952</b>	<b>FBB</b>	<b>49628</b>	<b>SS</b>	Plug, Valve	3
185	<b>48948</b>	<b>FBB</b>	<b>49623</b>	<b>SS</b>	Manifold, Discharge	1
188	87952	S	87952	S	Screw, HSH (M10x55)	10

Optional Parts And Accessories On Page 4

**Bold part numbers are unique to a particular pump model.**

†Production parts are different than replacement parts. R Components comply with RoHS Directive.

View Tech Bulletins 002, 003, 024, 035, 036, 043, 053, 074, 077, 083, 095 and 100 for additional information.

MATERIAL CODES (Not Part of Part Number): AL=Aluminum ALE=Aluminum Epoxy BB=Brass CC=Ceramic CM=Chrome-moly

FBB=Forged Brass FCM=Forged Chrome-moly FPM=Fluorocarbon NBR=Medium Nitrile (Buna-N) PVDF=Polyvinylidene Fluoride S=304SS

SHS=304SS/High Strength SS=316SS ST4=Special PTFE 4 STCP=Steel/Chrome Plated STL=Steel TNM=Special High Strength

# EXPLODED VIEW

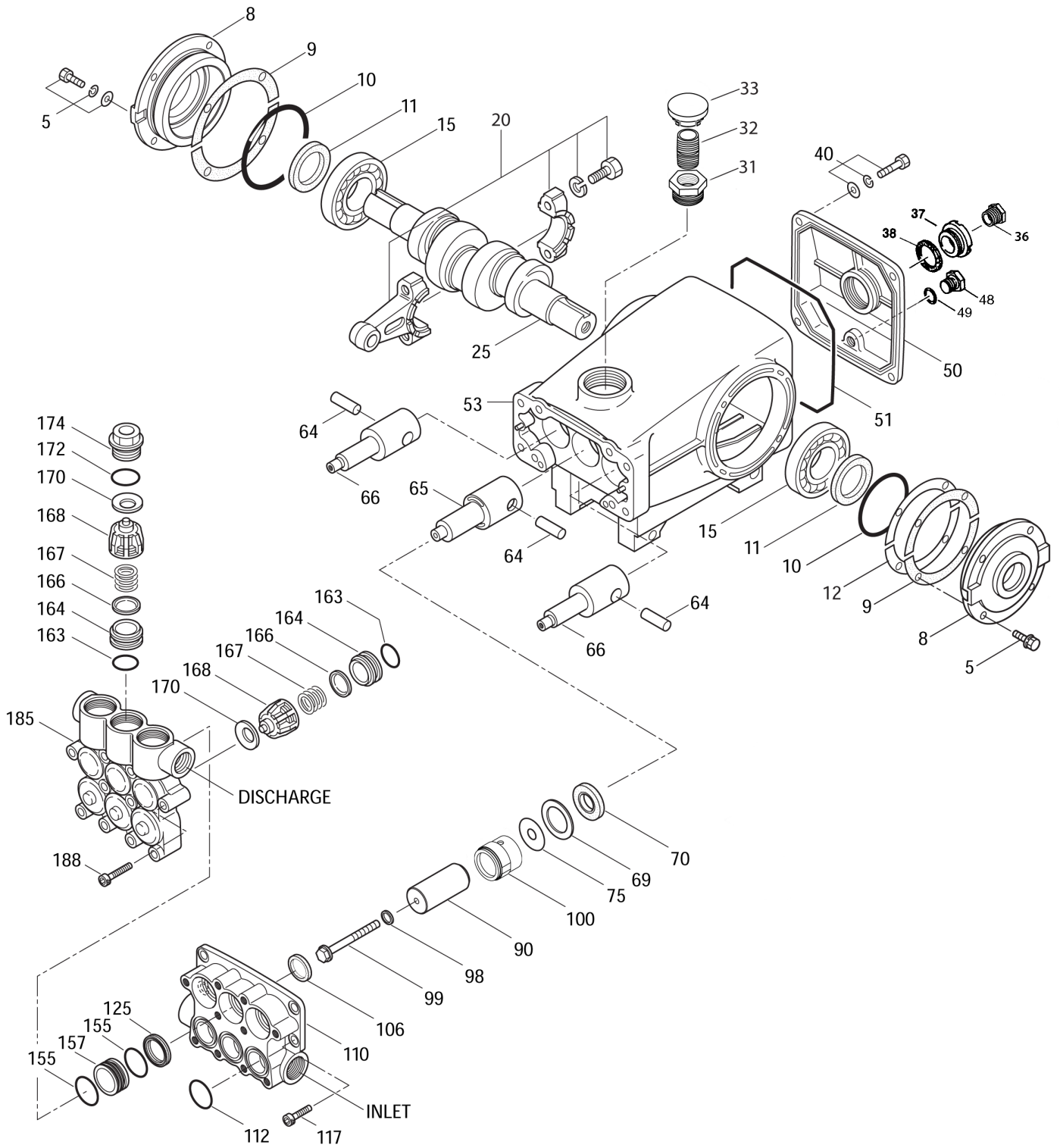

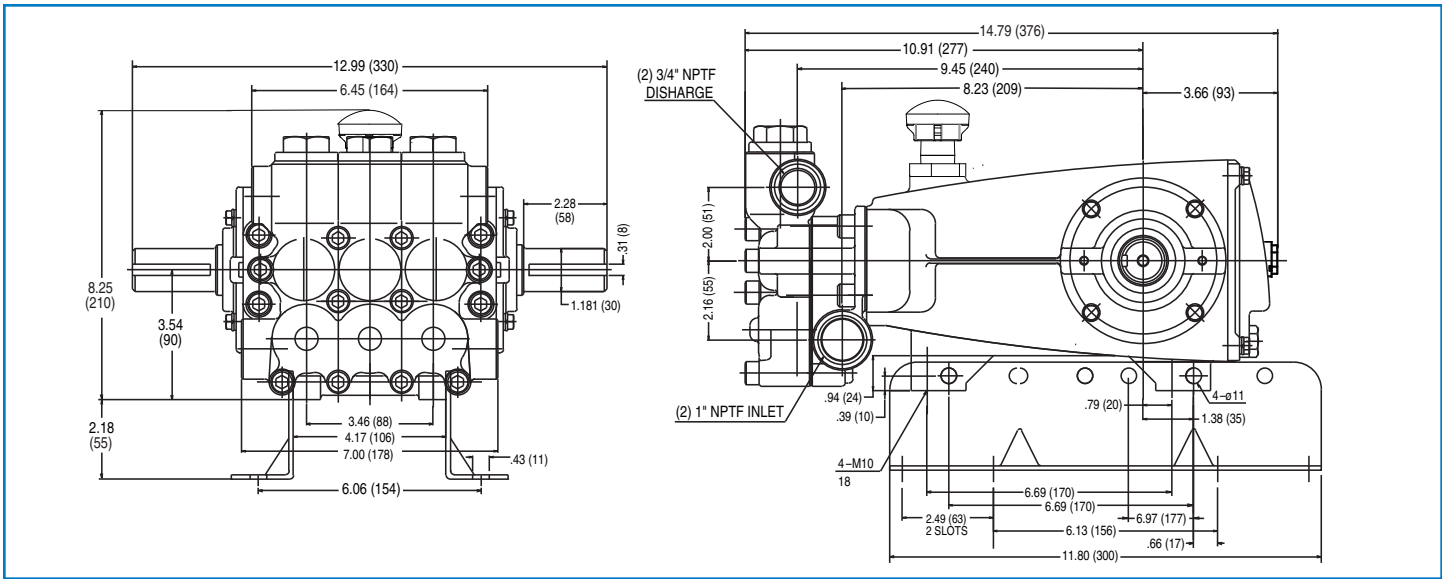

Model  
Brass - 1540E.44101  
Stainless Steel - 1541.44101  
November 2011

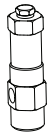
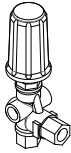
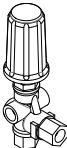

Models 1540E.44101, 1541.44101

## OPTIONAL PARTS AND ACCESSORIES

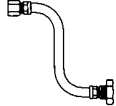
Part Number	Description	QTY		
7022/ 7022.100	Regulator (Primary Pressure Control)	1		
7534.0110/ 7531.0110	Unloader (Primary Pressure Control)	1		
7534.1110/ 7531.0110	Relief Valve (Secondary Pressure Control)	1		
7534.1110/ 7531.1110	Pop-Off Valve (Secondary Pressure Control)	1	7022 7022.100	7534.1100 7531.1110
6073	Pressure Gauge	1		
6013	Accumulator	1		
30613	Mounting Rails	1	7534.0110 7531.1110	6073
30067/ 990036	Key (M8x7.5x25)/( M8x7x40)	1		
76334	Kit, Oil Indicator (3/8" x 24") See Individual Data Sheet	1		
34334	Kit, Oil Drain (3/8" x 24") See Individual Data Sheet	1		
76093	Kit, Seal (Includes Items 98, 106, 112, 125, and 155)	1		
76775 (1540E.44101)	Kit, Valve (Includes Items 163, 164, 166,167, 168 170 and 172)	2	6013	34334
76450 (1541.44101)	Kit, Valve (Includes Items 163, 164, 166,167, 168 170 and 172)	2		
816863.44101/ 818443.44101	Complete Head	1		
30696	Pliers (Reverse)	1		
44050	Tool, Sight Gauge Removal	1		
6107	Oil, Bottle (21 oz.) ISO 68 Hydraulic	2	6107	30613
6119	Lubricant, Antiseize (1 oz.)	1		

**Demand Genuine Cat Pump Parts And Accessories.**



**CAT PUMPS**  
 1681 - 94TH LANE N.E. MINNEAPOLIS, MN 55449-4324  
 PHONE (763) 780-5440 — FAX (763) 780-2958  
 e-mail: techsupport@catpumps.com  
 www.catpumps.com